

## **BALL BURNISHING OF INTERNAL TURNED SURFACES**

**AsmaaT. M., Kesba M. M., Abu-Gharbia F.**

**Production Engineering and Mechanical design department, Faculty of Engineering,  
Minia University, Egypt. 61111.**

### **ABSTRACT**

The paper presented is a work started in summer 2014 for improving surfaces of turned holes. The work was confined to two materials; aluminum alloy and brass alloy. The internal machined surfaces were burnished by ball burnishing tools. Experimental work was carried out on a lathe machine to establish the effect of the internal ball burnishing parameters; namely, burnishing feed rate, speed and number of tool passes on the Surface roughness and surface hardness. The operation was carried out at load pushing speed 24 m/min through the hole. Turned Al-Br specimens were divided into groups, the parameters were changed with each group. The optimum values of surface roughness and surface hardness were obtained where the surface roughness improved from 3.14  $\mu\text{m}$  to 0.14  $\mu\text{m}$  for Al  $\mu\text{m}$  and from 2.25 to 0.16 for brass and the surface hardness improved from 116 HV to 184 HV for Al and from 182 to 244 HV for brass.

### **KEYWORDS**

**Ball Burnishing, Surface roughness, surface hardness.**

### **INTRODUCTION**

Burnishing is a cold rolling process without removal of metal. A set of balls rolls on the surface of component as result of which all the pre-machined peaks get result into valleys thus giving mirror like surface. The burnishing is chipless machining which can be used to improve the surface roughness and surface hardness on any metallic surfaces. Machined surfaces by conventional manufacturing processes such as turning and milling have inherent irregularities and defects like tool marks and scratches that cause energy dissipation (friction) and surface damage (wear) [1].

Work on the burnishing process has been investigated by various researches on lathes and milling machines for a wide range of materials. F. Gharbi, S. et al., [2], focused on the effect of the burnishing force on the surface quality and on the service properties of AISI 1010 steel hot-rolled plates. The optimal burnishing parameters had been determined to be 300 N, 235 rpm, and 0.18 mm/rev. At the optimal condition of burnishing force, the ductility of AISI 1010 steel was improved by 49%.

Prafulla Chaudhari and An and Nilewar, [1], used double ball burnishing process with turning without releasing the work-piece. The surface roughness improved from about  $R_a=2.5$  to about  $0.2 \mu\text{m}$ , and roundness error from about  $7.3$  to about  $2 \mu\text{m}$ . The best results of surface roughness and roundness error were obtained with burnishing force of  $150\text{N}$ . The smaller roundness error also can be achieved by using burnishing speeds between  $60.3$ , and  $85.7 \text{ m/min}$ . with a burnishing feed of  $0.11 \text{ mm/rev}$ .

Ibrahim A. A. et al., [3], investigated the influence of burnishing parameters on AISI 1018 Low Carbon Steel specimens by applying a new burnishing technique that enables both single and double ball burnishing process in site after turning without releasing the specimen. The surface roughness of the turned test specimens were improved by burnishing from about  $R_a = 2.4$  to about  $0.09 \mu\text{m}$ . Optimum conditions of a Surface finish was obtained with double ball burnishing process at burnishing force of  $210\text{N}$ , speed of  $85.7 \text{ m/min}$ , burnishing feed of  $0.11 \text{ mm/rev}$ , and number of tool pass was three.

The analysis on ball burnished plane surface, mild carbon steel finish and hardness improvements of around  $89 \%$  and  $70 \%$  respectively were obtainable M1044 was undertaken by Majeed Nemat et al., [4], the plane burnished surface. Around  $35 \mu\text{m}$  physical depth of the hardened surface layer was the result at the obtained optimum burnishing force and feed values of about  $78 \text{ N}$  and  $107 \text{ mm/min}$  respectively.

## EXPERIMENTAL

### Test equipment

The experimental work was conducted on a simple lathe machine (ZMM Sliven-universal lathe type cy630). The burnishing setup was used where an apparatus compression testing that shown in fig. (1) was fixed to the three jaw lathe chuck which clamped the work piece. The lathe guide was used to push the burnishing ball axially through the hole with the aid of grease. The operation was carried out at load pushing speed of  $24/\text{min}$  through the hole. The axial force was about  $100 \text{ N}$ , measured by the dynamometer. Turned Al-Br specimens were divided into groups. The parameters were changed with each group and their influence on surface roughness and surface hardness were studied.

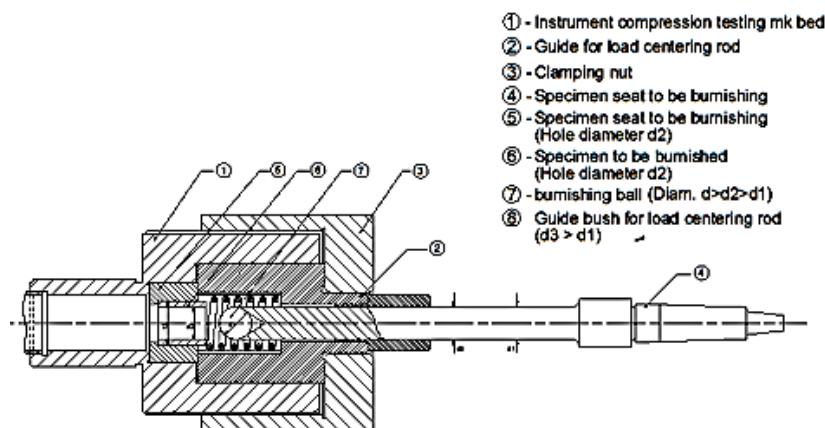

- ① - Instrument compression testing mk bed
- ② - Guide for load centering rod
- ③ - Clamping nut
- ④ - Specimen seat to be burnishing
- ⑤ - Specimen seat to be burnishing (Hole diameter  $d_2$ )
- ⑥ - Specimen to be burnished (Hole diameter  $d_2$ )
- ⑦ - burnishing ball (Diarn.  $d > d_2 > d_1$ )
- ⑧ - Guide bush for load centering rod ( $d_3 > d_1$ )

Fig. 1 The apparatus.

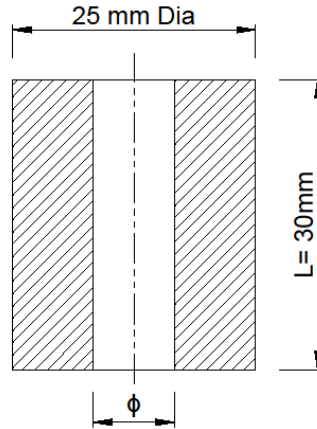

**Fig. 2 The work-piece.**

**Table. 1 Percentage of chemical composition (wt. %) of Aluminium alloy.**

Ni	Fe	Cu	Mn	Si	Mg
1-1.5%	1.1-6.1%	1.9-2.5%	.02%	0.5-1.2%	1.4-1.8%

**Table. 2 Percentage of chemical composition (wt. %) of Brass alloy.**

Cu	Zn
70 %	30 %

#### Test specimens

The work-pieces were received as hollow cylindrical bars of 25 mm diameter. The bars were cut to appropriate lengths (30 mm) and internally turned to a diameter of 10, 15 and 20mm as shown in fig.2. The tolerance of the set of aluminium samples was 0.2 mm and for the brass samples was 0.1 mm.

#### The balls-tools

Hard balls extracted from ball bearing have been used as the burnishing tools, their diameters are 10, 15 and 20 mm. These balls are commercially available in ball bearings and are made of carbon-chromium steel.

#### The burnishing parameters

The parameters affecting the plastic deformation process are variable, in the present work, the parameters selected are; the ball diameter, the burnishing feed, the burnishing speed and the number of burnishing tool passes.

#### Measurement of the surface roughness values

Initial surface roughness ( $R_a$ ) of aluminium and Brass measured after turning. The initial surface roughness  $R_a$  of most work materials was ranged between 2.67 to 3.65  $\mu\text{m}$  for

aluminium and from 1.86 to 2.64  $\mu\text{m}$  for brass. Then  $R_a$  was measured again for each specimen after ball burnishing process by the device illustrated in Fig. 3.



**Fig. 3 Surface roughness measurement device.**

#### **Measurement of the surface hardness values**

Small pieces have been cut from each work-piece to enable the measurement then located in its place on the adjusted device (Vickers hardness tester) indicated in fig.(4). The subjected load was 980 N. The initial hardness of aluminium HV was found to be in the range of 114 to 118  $\text{kgf/mm}^2$  and from 180 to 185  $\text{kgf/mm}^2$  for brass. The final surface hardness values (HV) are measured after ball burnishing process for each work-piece.



**Fig. 4 The hardness tester.**

## **RESULTS AND DISCUSSION**

### **3.1 Effect of the burnishing Feed rates on surface roughness**

The effects of burnishing feed on the  $R_a$  for both work-piece materials are shown in figures 5 and 6, respectively. The figures show that the surface roughness decreases with the increase of the burnishing feed then starts to increase after a certain point. At high feeds, the ball creates feed marks with a centerline distance between two consecutive

indentations that is large compared to the contact area between the tool and work-piece, and hence less improvement in the surface is available.

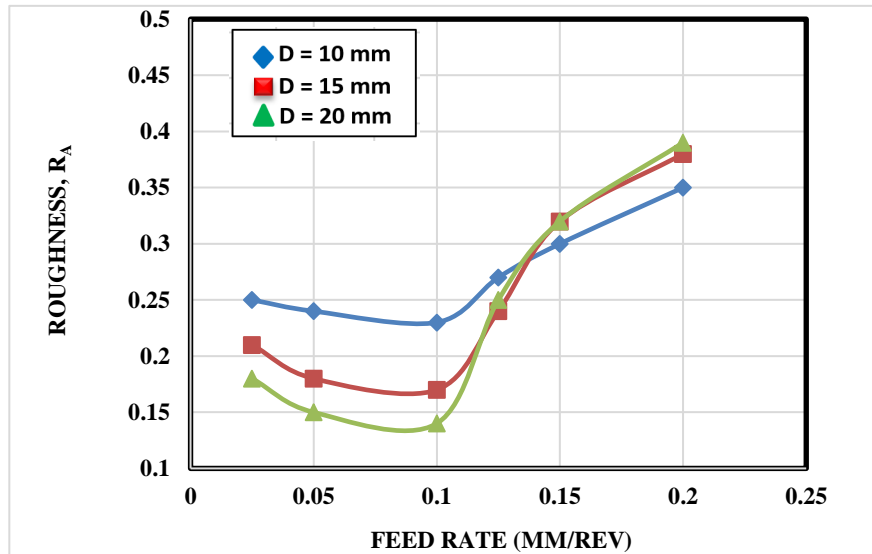

Fig. 5 Effect of burnishing feed rate on surface roughness.

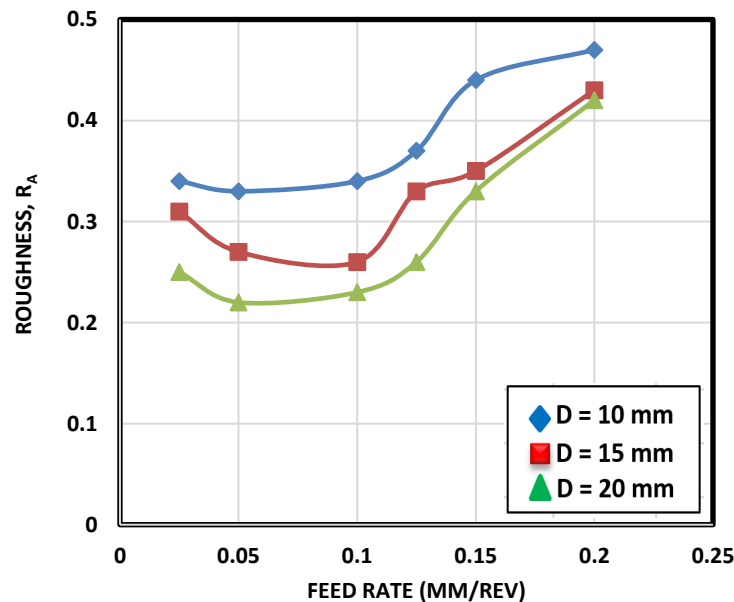
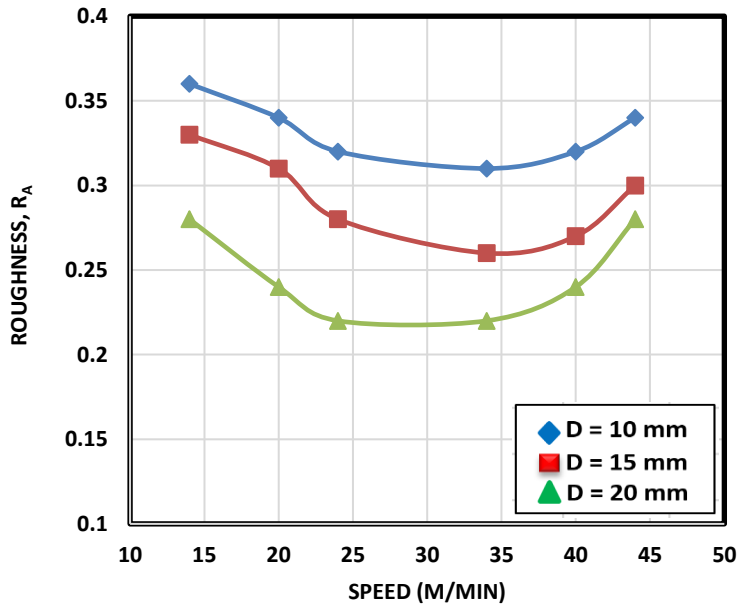

Fig. 6 Effect of burnishing feed rate on surface roughness.

#### Effect of the burnishing speed on the surface roughness

The relations between burnishing speed and surface roughness are shown in Figs. 7 and 8. It showed the effect of burnishing speed on surface roughness at constant feed rate of 0.1mm/rev., under a constant burnishing force  $p = 100$  N. As the speed increases, the roughness decreases to a certain limit then starts to increase. This is due to chattering occurring at higher speeds and less deformation time being available for the tool to smooth out more irregularities and harden the surface.



**Fig. 7 Effect of the burnishing speed on the surface roughness.**

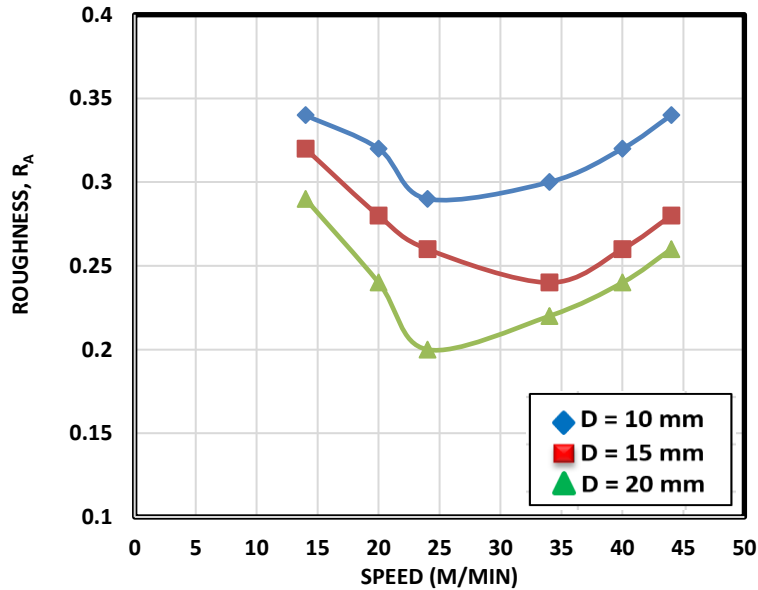

**Fig. 8 Effect of the burnishing speed on the surface roughness.**

**Effect of the number of tool passes on the surface roughness**

Ball burnishing curves in figures 9 and 10 indicated that the surface roughness reached a minimum value by pass number 3, after which it started to increase with further increase in the number of passes. In each pass, the tool is applied under a constant burnishing force to the plastically deformed surface of the previous pass. Similar to the effect of burnishing

force, after a particular number of passes, the surface layer becomes highly work-hardened, causing flaking to occur.

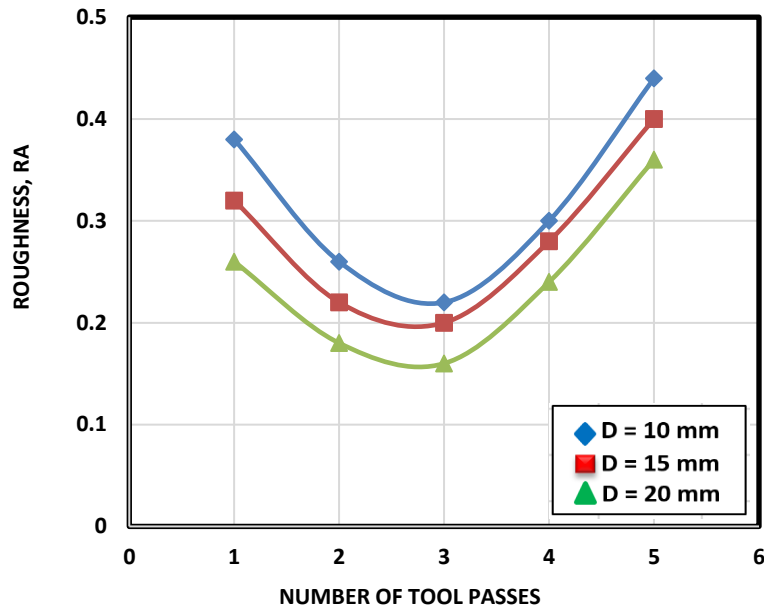

Fig. 9 Effect of the number of tool passes on the surface roughness.

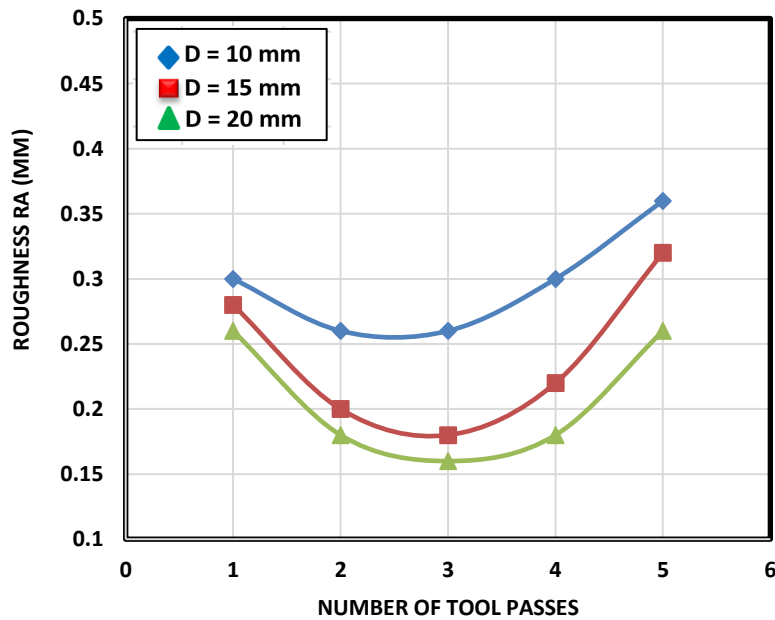

Fig. 10 Effect of the number of tool passes on the surface roughness.

#### Effect of the feed rates on the surface hardness

As the burnishing feed rate increases, the surface hardness decreases for both materials aluminum and brass work-pieces as shown in figures 11 and 12 at the same process

conditions of  $P = 100 \text{ N}$ ,  $V = 24 \text{ m/min}$  and number of passes = 1. This is due to as the feed rate increase, the heat subjected to the surface increases.

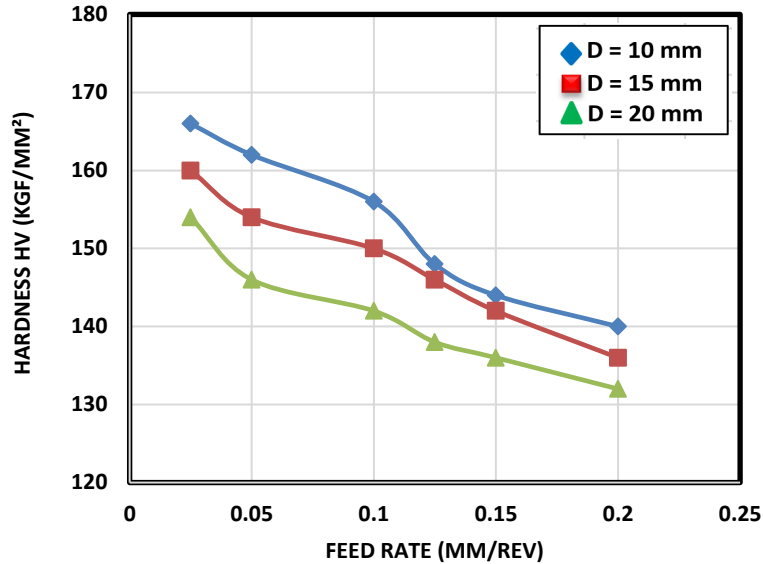

Fig. 11 Effect of the feed rates on the surface hardness.

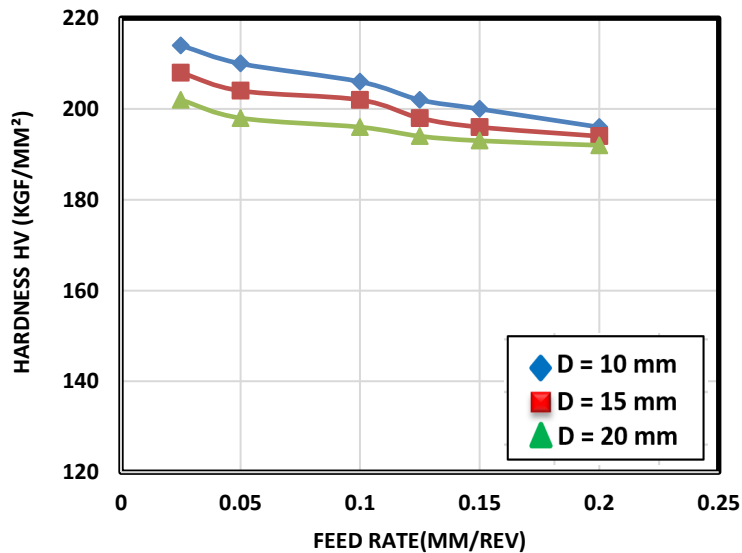

Fig. 12 Effect of the feed rates on the surface hardness.

#### Effect of the burnishing speed on the surface hardness

In figures 13 and 14, the hardness of the work-pieces surfaces considerably decreases with the increase of the burnishing speed. This behavior can be explained that in strain hardening, when a metal is strained beyond the yield point. More stress is required to produce additional plastic deformation and the metal apparently becomes stronger and more difficult to deform.



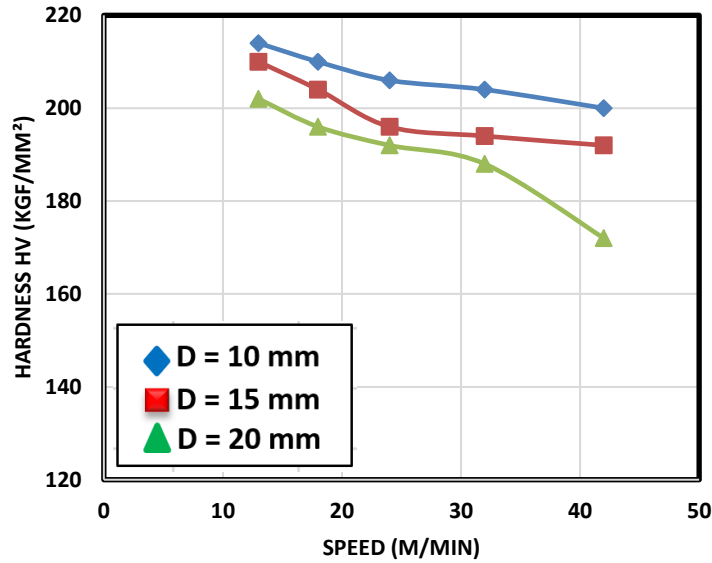

Fig. 13 Effect of the burnishing speed on the surface hardness.

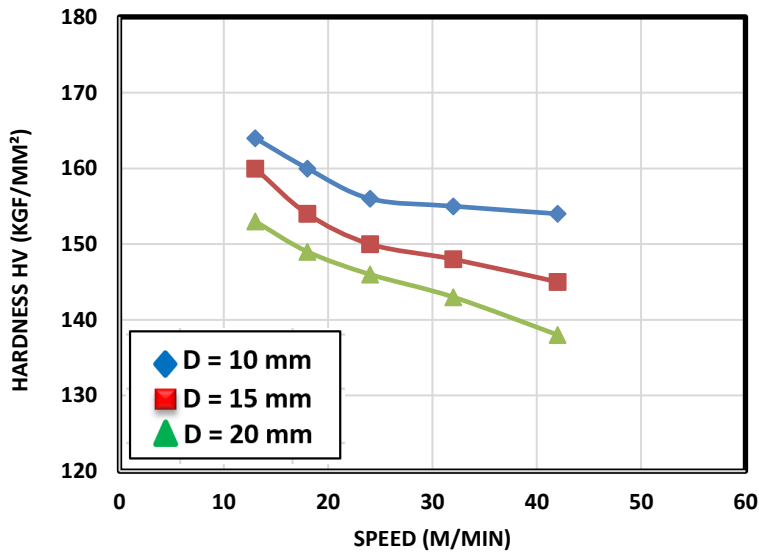
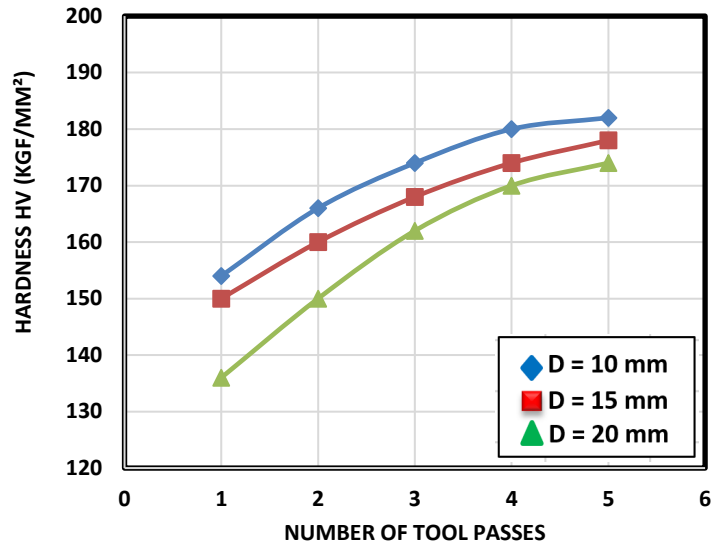

Fig. 14 Effect of the burnishing speed on the surface hardness.

**Effect of the number of tool passes on the surface hardness**

Figures 15 and 16 show the surface hardness (HV) owing to increases for both workpiece materials used by increasing the number of tool passes under constant conditions  $f = 0.1$  mm/rev,  $V = 24$  m/min and  $P = 100$  N. This can be attributed to the condensed grain structure and the increase in the structural homogeneity of the surface layers.



**Fig. 15 Effect of the number of tool passes on the surface hardness.**

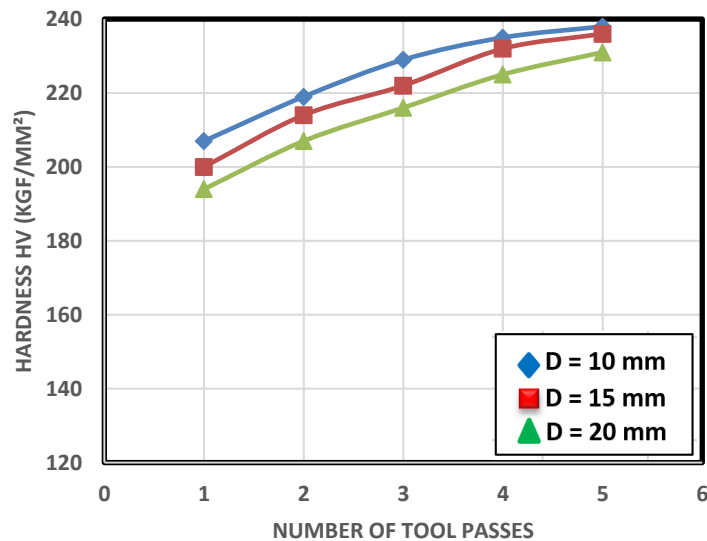

**Fig. 15 Effect of the number of tool passes on the surface hardness.**

## CONCLUSIONS

Under the burnishing conditions considered in the experimental work described before, the following conclusions can be drawn:

1. The surface roughness decreases with the increase of the feed rate, burnishing speed, burnishing force and number of tool passes, to a certain limit then starts to increase with each of the above mentioned parameters.
2. The surface hardness decreases with the increase of the feed rate, burnishing speed, while the surface hardness increases with the increase of burnishing force and the number of tool passes.

3. The size of burnishing ball has a significant effect on surface roughness and surface hardness. Increasing the burnishing force causes a significant increase in the surface hardness.
4. Large diameter's ball seems to be more effective in improving the surface roughness, while small diameter's balls seem to be more effective in increasing the surface hardness.
5. A surface roughness  $R_a = 0.14 \mu\text{m}$  of aluminium and  $R_a = 0.16 \mu\text{m}$  of brass have achieved via ball burnishing process.
6. The experimental work shows that an increase in surface hardness from 116 HV to 184 HV of aluminium and from 182 HV to 244 HV for brass.
7. Brass has better results than aluminium.
8. The burnishing technique followed in the study proved to be a very efficient method in improving all surface qualities of machined surfaces.

#### REFERENCES

1. Chaudhari P. and Nilewar A., "An investigation of effect of combined turning and ball burnishing dual process on the surface roughness performed on lathe", *International Journal of Engineering Science Invention Research & Development*, pp. 375 - 380, (2015).
2. Gharbi F., Sghaier S., Morel F., and Benameur T., "Experimental investigation of the effect of burnishing force on service properties of AISI 1010 steel plates", *JMEPEG*, pp. 721-725, (2015).
3. Ibrahim A. A., Tamer Khalil and TarekTawfeek, "Study the influence of a new ball burnishing technique on the surface roughness of AISI 1018 low carbon steel", *International Journal of Engineering & Technology*, pp. 227 - 232, (2015).
4. Némat M., Khleif A. A. and Abbas A. A., "Effect of burnishing force and feed on the depth of the surface hardness layer in plane surface ball burnishing", *The Iraqi Journal For Mechanical And Material Engineering*, 2016, pp. 463 - 476, (2016).