

**EFFECT OF TIP RADIUS OF THE INDENTERS ON FRICTION
COEFFICIENT OF THE SCRATCHED METALLIC SHEETS**

Al-Grafi M.¹, Mahmoud M.¹ and Ali W. Y.²

¹College of Engineering, Taibah University, Al Madina Al Munawara, Saudi Arabia.

²Faculty of Engineering, Taif University, Al -Taif, Saudi Arabia.

ABSTRACT

The objective of the present work is to perform a scratch test to measure the abrasion wear resistance of metallic sheets. Besides, the deformation modes and the friction processes involved during the scratching will be investigated in order to get a better insight into the wear mechanisms observed at the macroscopic scale. The study of scratch formation will be combined with an analysis of the frictional response of the tested materials. The effect of the tip radius of 0.04, 0.3 and 0.45 mm of the indenters on the friction coefficient displayed by scratching metallic sheets of aluminium, steel and brass is discussed.

It was found that, metallic sheets scratched by all indenters showed lower friction coefficient for lubricated surface than dry ones, where friction coefficient slightly increased with increasing normal load. For dry aluminium surface friction coefficient significantly increased up to maximum value, (1.4), then decreased with increasing load for 0.03 mm tip radius. The relative decrease in friction displayed by lubricated steel was relatively lower compared to that observed for aluminium. At 12 N friction coefficient showed consistent trend with further load increase due to the strain hardening of steel. The scratch of brass sheet displayed higher values of friction coefficient than steel and lower than aluminium. Friction coefficient significantly increased up to maximum then decreased with increasing load for dry and lubricated surfaces.

Increasing the tip radius of the indenter up to 0.3 mm showed an increase in friction coefficient of aluminium sheet. Scratch of the steel sheet showed relative friction decrease compared to that observed for aluminium. The difference in friction values between dry and lubricated surfaces was small. As the tip radius of the indenter increased to 0.45 mm friction coefficient decreased for aluminium sheet. As the load increased the difference in friction coefficient between dry and lubricated conditions increased. The lubricated steel surface showed an increasing trend with load increase with lower friction values. The friction difference represented higher values at higher loads. The lowest friction values were represented by brass sheet. The influence of lubrication on the friction coefficient is clearly noticed at higher values of load.

KEYWORDS

Friction coefficient, scratch, indenter, tip radius, aluminium, steel, beass.

INTRODUCTION

Abrasion wear caused by sand particles is the prevailing mode of wear in the Arabic nations especially in the kingdom of Saudi Arabia. The relative increase in the concentration of airborne dust is responsible for the wear increase. Scratch resistance of engineering materials is one of the important performance requirements to withstand the wear of the moving surfaces in industrial applications. Scratch test provides a convenient mean to study the surface mechanical properties and the tribological performance of materials. Understanding of this test is of great interest to both academic and industrial communities, [1 – 4]. The scratch hardness and the surface deformation mechanisms of materials depend in particular on the rheology of the material, the indenter geometry and the friction at the interface.

An experimental and numerical study of the scratch test performed on metals and polymers was conducted to describe the scratch mechanism and to investigate whether or not important scratch quantities can be determined with sufficient accuracy from standard scratch experiments, [5]. The mechanism of scratching was divided into two different types. The first one was termed as mild scratching for tough materials, while the second type, termed as severe scratching, for materials of relatively low toughness, [6]. A numerical approach for modeling the scratch test (from a mechanical point of view) using the finite element method was introduced, [7]. It was found that there exists a representative level of plastic strain of approximately 35% at frictionless scratching, [8]. A number of parameters such as scratch depth and time dependence of polymeric materials may complicate the evaluations of the experiments when performing scratch experiments.

A linear relation between the applied forces, the scratch width and the scratch depth was introduced, [9]. The relation was validated using experimental scratch data on cement paste and sandstone, which showed that the proposed approach provided a convenient way to determine the fracture toughness from scratch tests carried out with different scratch widths and depths. Nano-scratch and nano-fretting tests were performed on highly polished biomedical grade Ti6Al4V, 316L stainless steel and Co Cr alloy samples using a 3.7 μm sphero-conical diamond indenter in a commercial nanomechanical test system (NanoTest), [10]. Over a wide range of experimental conditions the Co Cr alloy showed significantly better wear resistance.

In order to understand the failure mechanism of artificial joints it is necessary to understand the mechanism that governs roughening of metallic surface and subsequent damage nucleation and wear at the bearing interface. Scratching of the metallic surface by entrapped wear debris leading to increased polyethylene wear rates has been recognized as one of the main causes of early failure of total joint replacement, [11]. From the presence of these scratches it has been suggested by Li and co-workers that current biomedical materials do not provide adequate load support [12]. Scanning

electron microscopy analysis of the retrieved Co Cr heads has been performed, [13], showing four different types of third-body related damage.

It was demonstrated that if a scratch of certain size is created over the shot peened surface then the benefit can be reduced or even completely eliminated. The fatigue life and non-propagating cracks of scratch damaged shot peened components were predicted, [14 - 16]. A good agreement was found between the numerical predictions and experimental results. Some concern arises if the treated surface is damaged in some way, for example by a scratch. The use of scratch testing to measure the adhesion strength of calcium phosphate (CaP) coatings that were applied to a poly(carbonate urethane) (PCU) substrate by an aqueous process at temperatures of 19, 28, 37, and 50 °C was investigated, [17]. Preliminary study and critical examination of friction due to scratching of WSe₂ film were carried out. W Se₂ film was deposited using sputtering technique. The composition of the film was determined by means of energy dispersive spectrometry (EDS) and X-ray photoelectron spectrometry (XPS), [18]. The micro-structural features, topography and mechanical properties of the film were evaluated using transmission electron microscopy (TEM), atomic force microscopy (AFM) and nano-indenter. The film was scratched at different constant loads and also with increasing load using a scratch tester with a spherical indenter in macro-loading regime.

In the present work, sheets of aluminium, steel and brass were scratched by three indenters of 0.04, 0.3 and 0.45 mm of tip radius. Friction coefficient of the scratched specimens was determined.

EXPERIMENTAL

The test specimens of aluminium, steel and brass in form of sheets of rectangular cross section of 25 × 25 mm and 5 mm thickness were tested. Table 1 shows the chemical composition of the tested sheets. Tested materials were aluminium, steel and brass.

Table 1 Chemical composition of the tested sheets.

Aluminium, NS 4				
Al	Mn	Mg	Tensile strength, N/mm ²	Hardness, N/mm ²
95.5	0.5	2.5	173	500
Steel, St 34.11				
Carbon Content, wt. %		Tensile strength, N/mm ²		Hardness, N/mm ²
0.12		340 - 420		950 - 1200
Brass, CZ 103				
Cu	Zn	Tensile strength, N/mm ²		Hardness, N/mm ²
80	20	300		1150

Scratch tester shown in Fig. 1 was used. It consisted of a rigid stylus mount, where an insert made of titanium nitride of apex angle 90° and hemispherical tips of 0.04, 0.3 and 0.4 mm radius was installed. The insert was mounted to the loading lever through three jaw chuck. A counter weight was used to balance the loading lever before loading. Vertical load was applied by weights of 2, 4, 6, 8, 10, 12, 14, 18 and 24 N. Scratch resistance force was measured using a load cell mounted to the loading lever and connected to a digital monitor. The test specimens were held in the specimen holder

which mounted in a horizontal base with a manual driving mechanism to move specimen in a straight direction. The scratch force was measured during the test and used to calculate friction coefficient. The test was conducted under dry and paraffin oil lubricated conditions at room temperature.

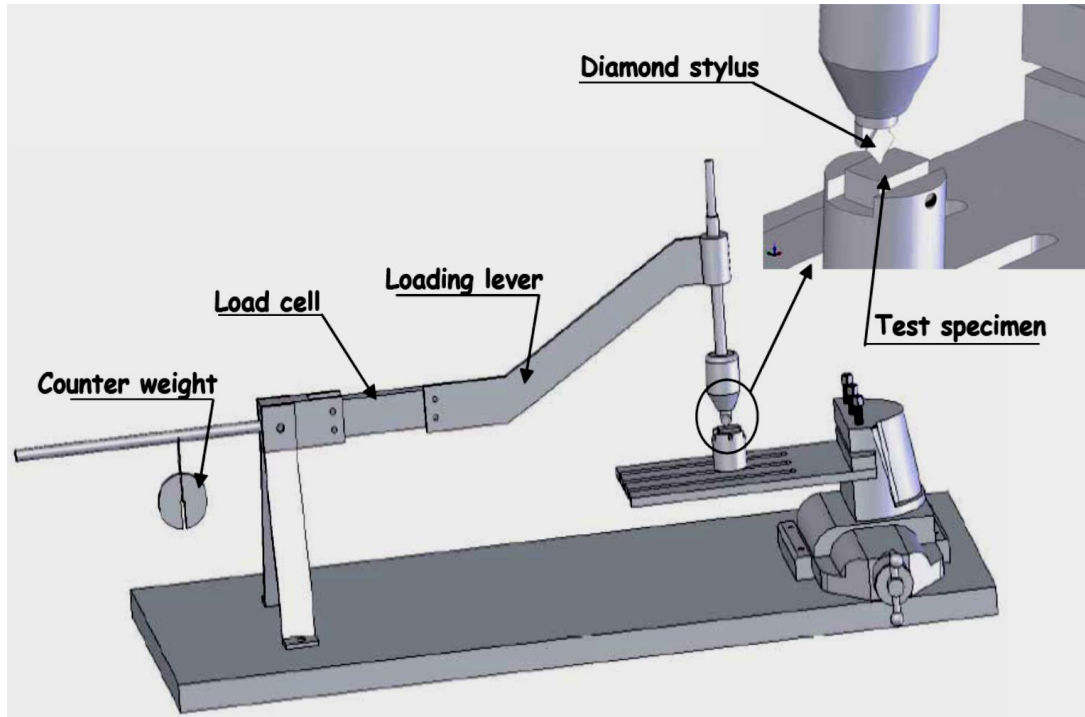

Fig. 1 Arrangement of scratch test rig.

RESULTS AND DISCUSSION

The results of experiments carried out to investigate the effect of radius of the tip of the indenter on friction coefficient are shown in Figs. 2 – 10. Friction coefficient displayed by the scratch of aluminium sheet by an insert of 0.04 mm tip radius is illustrated in Fig. 2. Lubricated surfaces showed lower friction coefficient than dry ones, where friction coefficient slightly increased with increasing normal load. For dry surfaces friction coefficient significantly increased up to maximum value, (1.4), then decreased with increasing load. The friction increase might be from the increase of the volume of the removed aluminium. The friction decrease could be from the fact that the applied stress exceeded the yield shear strength of the scratched aluminium. The effect of the lubricant is clearly shown in the relative difference on the friction coefficient.

Friction coefficient displayed by the scratch of steel sheet by an insert of 0.04 mm tip radius is shown in Fig. 3. Friction coefficient significantly increased with increasing load. The relative decrease in friction displayed by lubrication was lower compared to that observed for aluminium. The highest friction value was 1.0 for dry steel surface. At 12 N friction value showed consistent trend with further load increase due to the strain hardening of steel. It seems that at 12 N, the generated stress reached the yield strength.

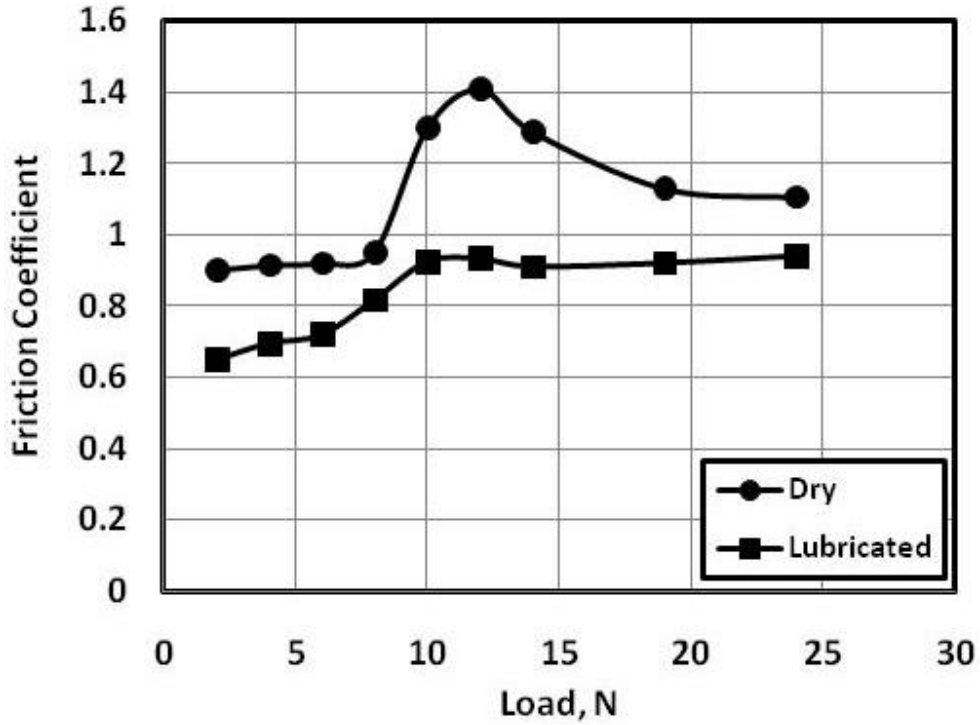

Fig. 2 Friction coefficient displayed by the scratch of aluminium sheet by an insert of 0.04 mm tip radius.

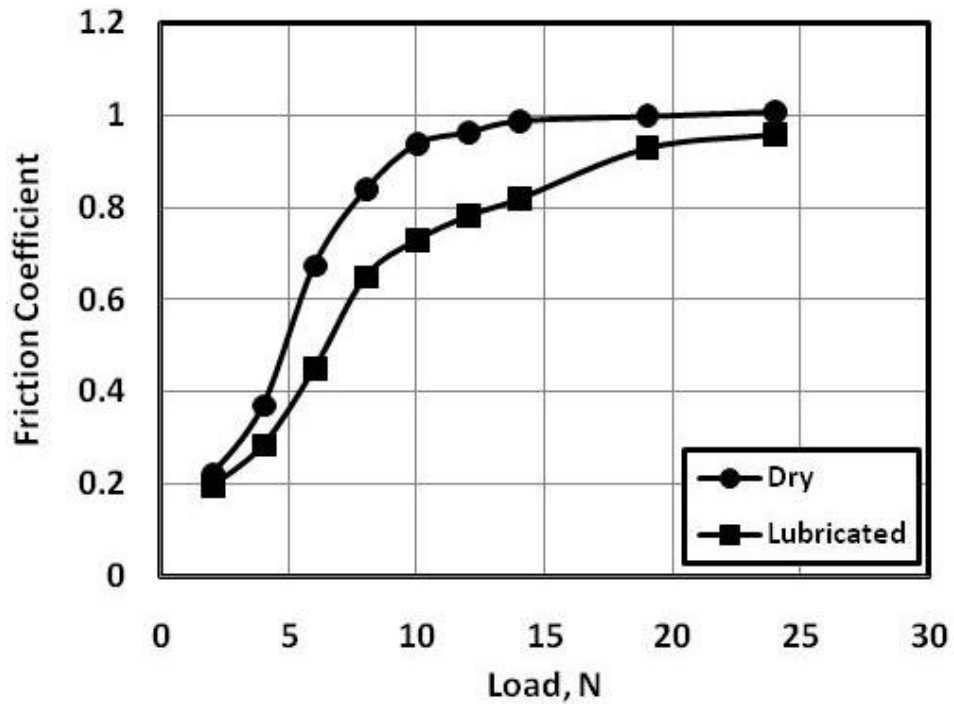

Fig. 3 Friction coefficient displayed by the scratch of steel sheet by an insert of 0.04 mm tip radius.

The scratch of brass sheet by an insert of 0.04 mm tip radius, Fig. 4, displayed higher values of friction coefficient than steel and lower than aluminium. Friction coefficient significantly increased up to maximum then decreased with increasing load for dry and lubricated surfaces. The decrease in friction showed that the strain hardening accompanied to the material deformation was not enough to balance the decrease in friction generated from the plastic deformation after yielding.

Increasing the tip radius of the indenter up to 0.3 mm showed an increase in friction coefficient of aluminium sheet, Fig. 5. This behaviour might be attributed to the increased shear area of aluminium. Lubricated surfaces showed relatively lower friction than dry one. The effect of lubrication is clearly shown in the plastic zone i.e. at loads higher than 14 N. Scratch of the steel sheet showed relative friction decrease compared to that observed for aluminium, Fig. 6. The friction decrease might be from the increased hardness of steel and the decrease of applied stress due to the increased cutting area. The difference in friction values between dry and lubricated surfaces was small. The load at which plastic deformation began was 18 N due to the increase of the shear area. Friction coefficient displayed by the scratch of brass sheet by an insert of 0.3 mm tip radius is illustrated in Fig. 7. The load at which plastic deformation began was 14 N, where the friction showed consistent trend with increasing load. The difference in friction increased at the plastic zone.

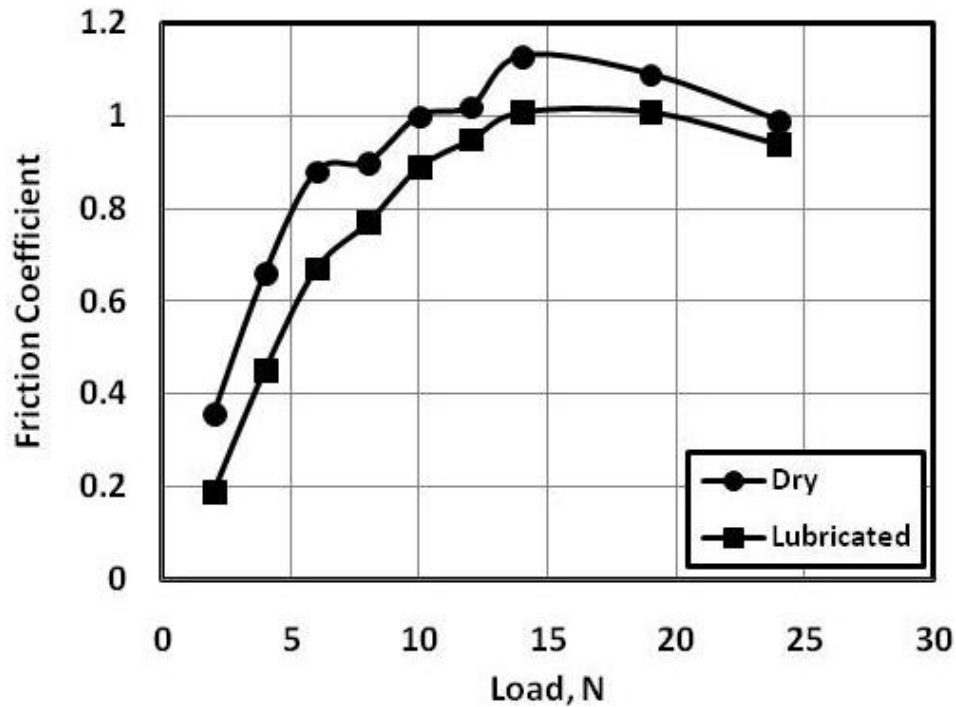

Fig. 4 Friction coefficient displayed by the scratch of brass sheet by an insert of 0.04 mm tip radius.

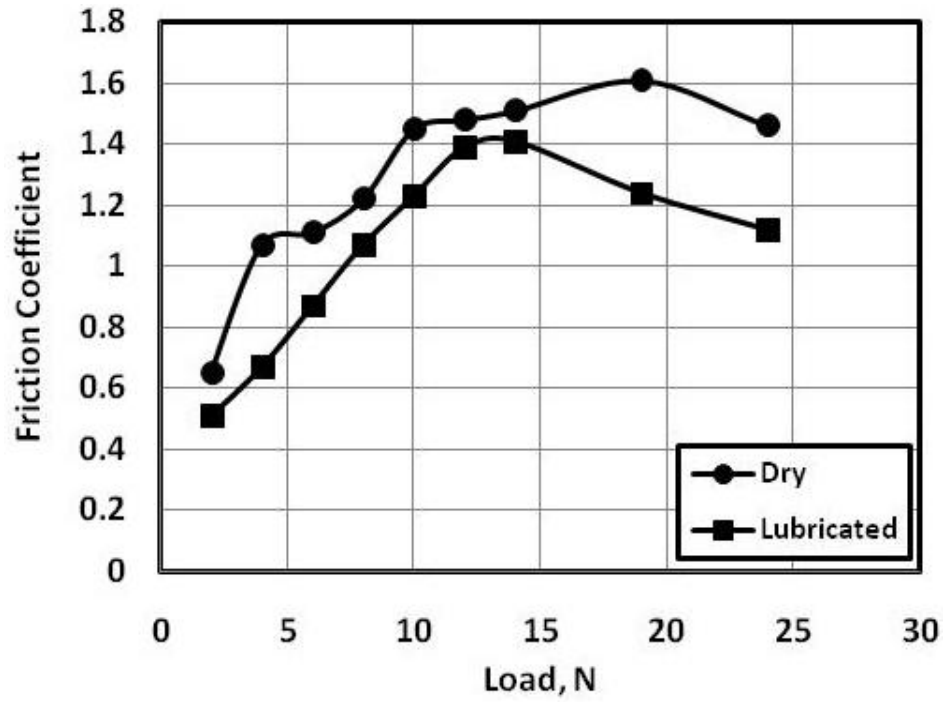

Fig. 5 Friction coefficient displayed by the scratch of aluminium sheet by an insert of 0.3 mm tip radius.

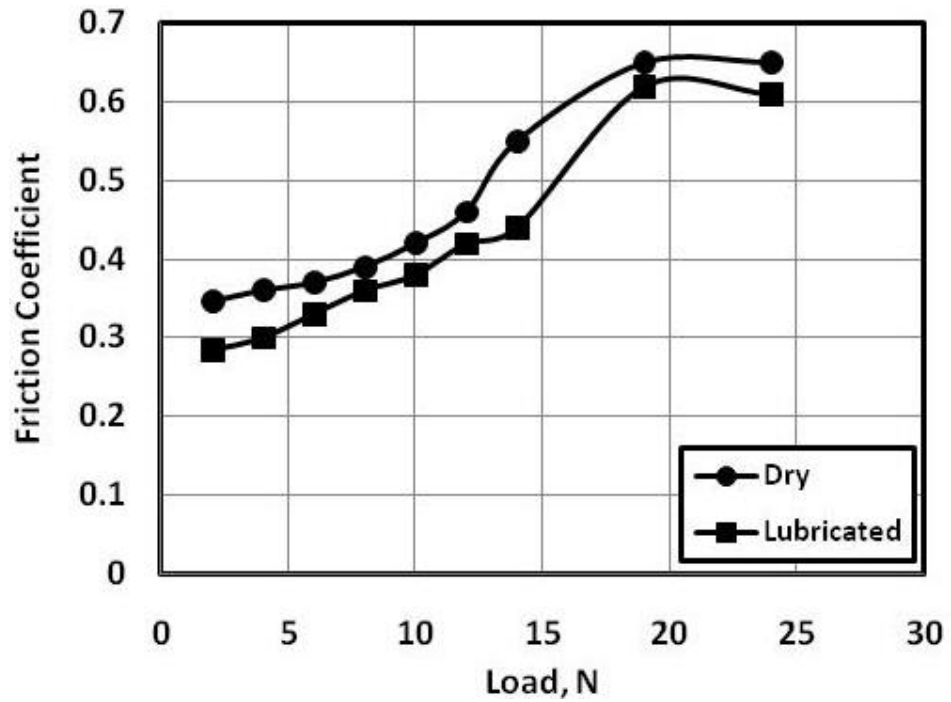

Fig. 6 Friction coefficient displayed by the scratch of steel sheet by an insert of 0.3 mm tip radius.

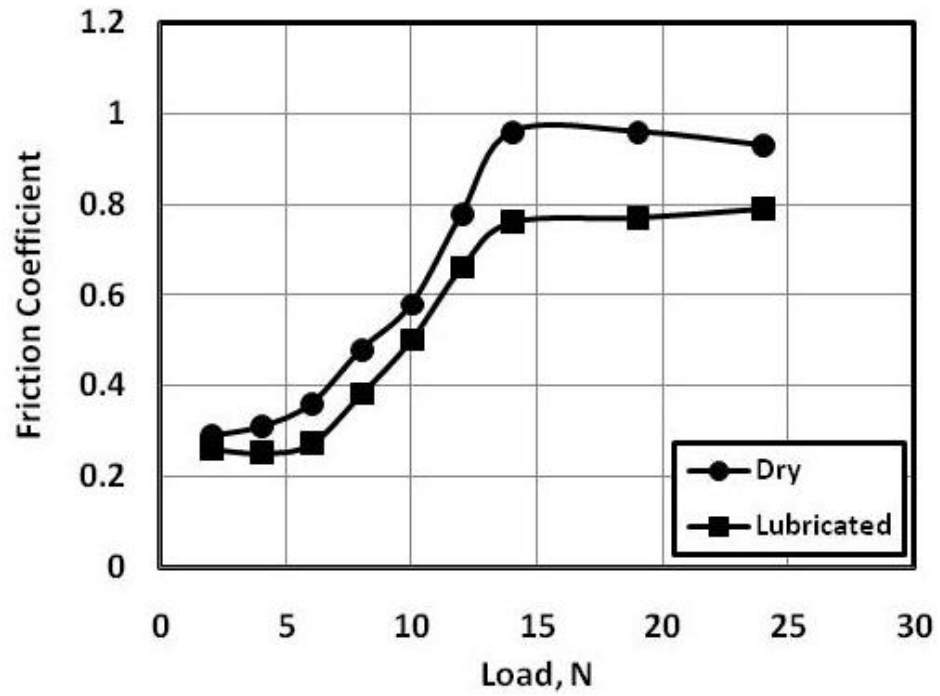

Fig. 7 Friction coefficient displayed by the scratch of brass sheet by an insert of 0.3 mm tip radius.

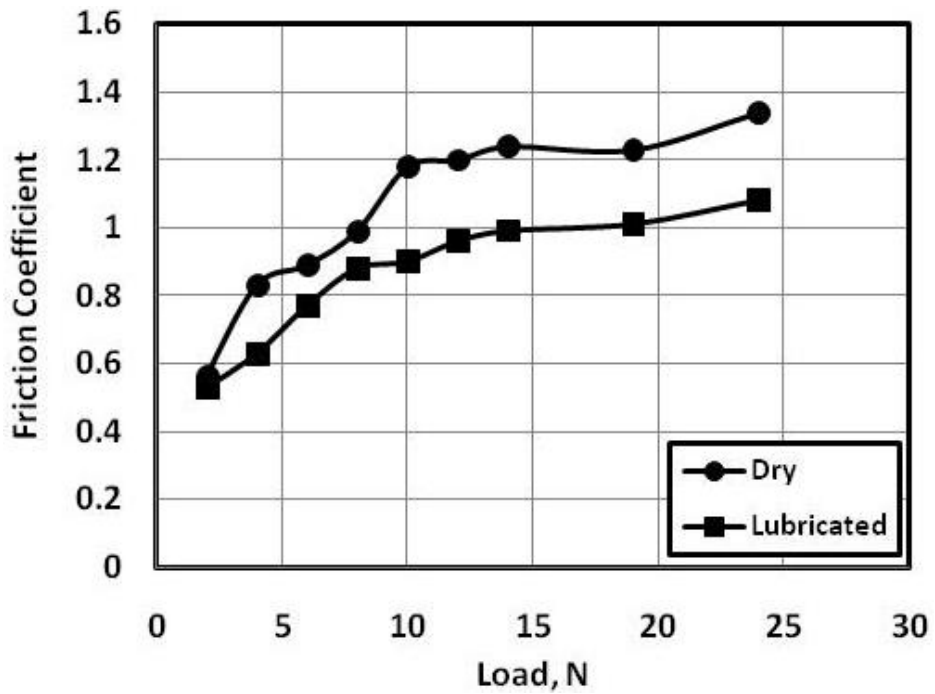

Fig. 8 Friction coefficient displayed by the scratch of aluminium sheet by an insert of 0.45 mm tip radius.

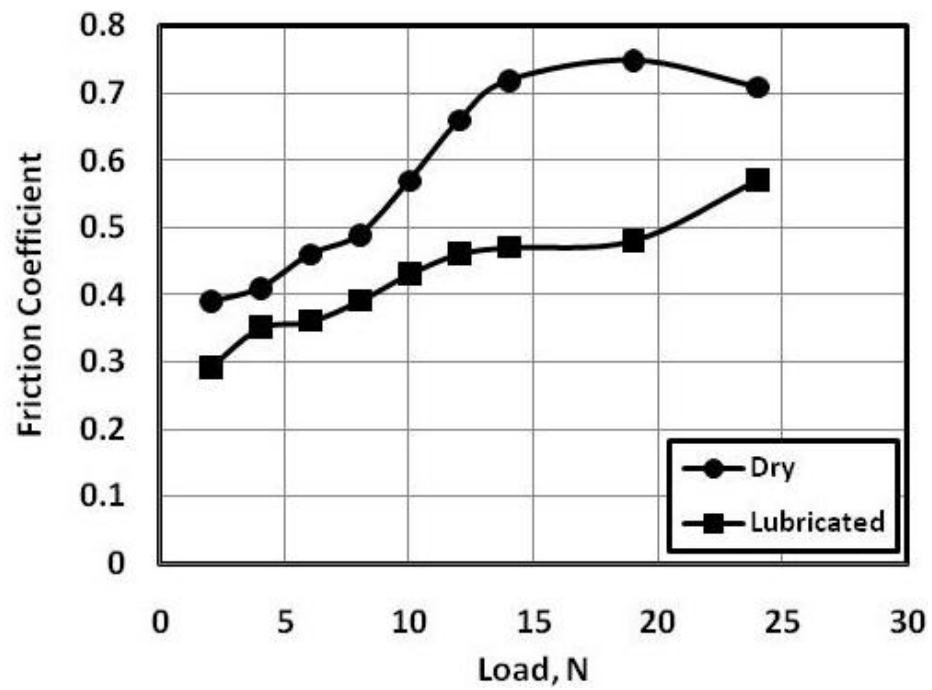

Fig. 9 Friction coefficient displayed by the scratch of steel sheet by an insert of 0.45 mm tip radius.

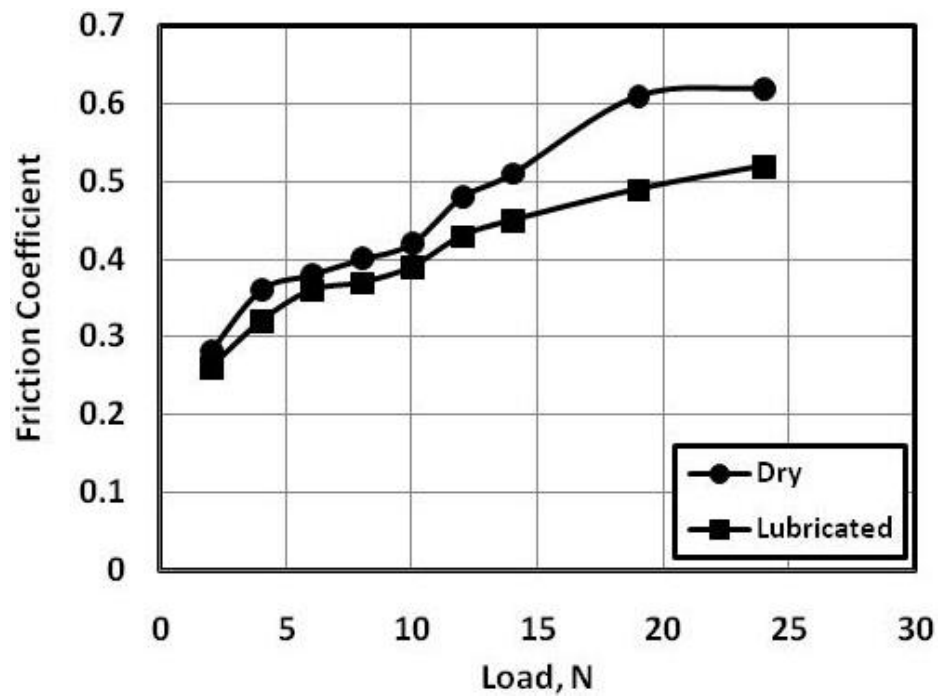

Fig. 10 Friction coefficient displayed by the scratch of brass sheet by an insert of 0.45 mm tip radius.

As the tip radius increased to 0.45 mm friction coefficient decreased for aluminium sheet, Fig. 8. Friction coefficient increased with increasing load. As the load increased the difference in friction coefficient increased. It seems that increasing tip radius decreased friction coefficient. The highest friction values were 1.32 and 1.08 at 24 N for dry and lubricated scratched aluminium.

Dry scratch of steel sheet by an insert of 0.45 mm tip radius showed friction increase up to maximum at 18 N load followed by decrease as the load increased to 24 N, Fig. 9. The lubricated surface showed an increasing trend with load increase with lower friction values. The friction difference represented high values at higher loads. The lowest friction values represented by brass sheet were observed for indenter of 0.45 mm tip radius, Fig. 10. The influence of lubrication on the friction coefficient is clearly noticed at higher values of load.

CONCLUSIONS

- 1. Metallic sheets scratched by indenter of 0.04 mm tip radius showed lower friction coefficient for lubricated surface than dry ones, where friction coefficient slightly increased with increasing normal load. For dry aluminium surface friction coefficient significantly increased up to maximum value, (1.4), then decreased with increasing load. The relative decrease in friction displayed by lubricated steel was relatively lower compared to that observed for aluminium. At 12 N friction value showed consistent trend with further load increase due to the strain hardening of steel. The scratch of brass sheet displayed higher values of friction coefficient than steel and lower than aluminium. Friction coefficient significantly increased up to maximum then decreased with increasing load for dry and lubricated surfaces.**
- 2. Increasing the tip radius of the indenter up to 0.3 mm showed an increase in friction coefficient of aluminium sheet. The effect of lubrication in decreasing friction is clearly shown in the plastic zone i.e. at loads higher than 14 N. Scratch of the steel sheet showed relative friction decrease compared to that observed for aluminium. The difference in friction values between dry and lubricated surfaces was small. The difference in friction displayed by the scratch of brass sheet increased at the plastic zone.**
- 3. As the tip radius increased to 0.45 mm friction coefficient decreased for aluminium sheet. As the load increased the difference in friction coefficient increased. The lubricated steel surface showed an increasing trend with load increase with lower friction values. The friction difference represented higher values at higher loads. The lowest friction values were represented by brass sheet. The influence of lubrication on the friction coefficient is clearly noticed at higher values of load.**

REFERENCES

- 1. Jardret V., Zahouani H., Loubet J. L., Mathia T. G., "Understanding and quantification of elastic and plastic deformation during a scratch test", Wear 218, pp. 8 - 14, (1998).**

2. Felder E., Bucaille J. L., “Mechanical analysis of the scratching of metals and polymers with conical indenters at moderate and large strains”, *Tribology International* 39, pp. 70 - 87, (2006).
3. Gauthier C., Durier A.-L., Fond C., Schirrer R., “Scratching of a coated polymer and mechanical analysis of a scratch resistance solution”, *Tribology International* 39 (2006) 88-98
4. Ali W. Y. and Mahmoud M., “Abrasive Wear of Polymeric Composites”, *Journal of the Egyptian Society of Tribology*, Vol. 6, No. 4, October 2009, pp. 50 - 59, (2009).
5. Wredenberg F. and Larsson P. L., “Scratch testing of metals and polymers: Experiments and numerics”, *Wear* 266, pp. 76 – 83, (2009).
6. Xie Y. and Hawthorne H. M., “A controlled scratch test for measuring the elastic property, yield stress and contact stress–strain relationship of a surface”, *Surface and Coatings Technology* 127, pp. 130 – 137, (2000).
7. Wredenberg F. and Larsson P. L., “On the numerics and correlation of scratch Testing”, *Journal of Mechanics of Materials and Structures* 2, pp. 573 – 594, (2006).
8. Briscoe B. J., Evans P. D., Biswas S. K. and Sinha S. K., The hardness of poly(methylmethacrylate), *Tribology International* 29, pp. 93 - 104, (1996).
9. Akono A. T., Ulm F. J., “Scratch test model for the determination of fracture toughness”, *Engineering Fracture Mechanics* 78, pp. 334 - 342, (2011).
10. Liskiewicz T. W., “Comparison of nano-fretting and nano scratch tests on biomedical materials. *Tribology International* (2012), <http://dx.doi.org/10.1016/j.triboint.2012.08.007>.
11. Najjer D., Behnamghader .A, Iost A., Migaud H., “Influence of a foreign body on the wear of metallic femoral heads and polyethylene acetabular cups of total hip prostheses”, *Journal of Materials Science*, 2000, 35, pp. 4583 - 4588, (2000).
12. Li X., Wang X., Bondokov R., Morris J., An Y. .H, Sudarshan T. S., “Micro/nanoscale mechanical and tribological characterization of SiC fo orthopaedic applications”, *Journal of Biomedical Materials Research Part B, (Applied Biomatererials)*, 72B, pp. 353 - 61, (2004).
13. Raimondi M. T., Vena P., Pietrabissa R., “Quantitative evaluation of the prosthetic head damage induced by microscopic third-body particles in total hip replacement”, *Journal of Biomedical Materials Research Part B, (Applied Biomatererials)*, 58, pp. 436 - 448, (2001).
14. Cláudio R. A., Silva J. M., Branco C. M. and Byrne J., “A fracture mechanics based approach to predict fatigue life of scratch damaged shot peened components”, *Procedia Engineering* 10, pp. 2672 - 2677, (2011).
15. Benedetti M., Fontanari V., Santus C., Bandini M., “Notch fatigue behaviour of shot peened high-strength aluminium alloys: Experiments and predictions using a critical distance method”, *I J of Fatigue*, 2010, 32, pp. 1600 - 1611, (2010).
16. Cláudio R.A., Silva J.M., Branco C.M., Byrne J., “The ability of current models for fatigue life prediction of shot peened components”, *Key Eng Mat*, pp. 417 – 418, pp. 901 - 904, (2010).
17. Barnes D., Johnson S., Snell R. and Best S., “Using scratch testing to measure the adhesion strength of calcium phosphate coatings applied to poly(carbonate urethane) substrates”, *Journal of the Mechanical Behavior of Biomedical Materials*, 6, pp. 128 - 138, (2012).

**18. Cetinkaya K., “An effect of feeding system on the scratches of sheet metal strips”,
Materials and Design 28, pp. 362 - 367, (2007).**